

## Features

- 2-pin lead-less package
- Low Junction capacitance (Max value: 450pF)
- Peak Pulse current (8/20  $\mu$ s) MAX : 125A
- IEC61000-4-2 (ESD)  $\pm$ 30kV (air),  $\pm$ 30kV (contact)
- Low leakage current
- Working voltages:4.5V
- RoHS Compliant

## Appearance & Symbol

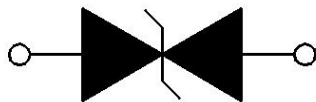

Bi-directional

## Mechanical characteristics

- Package: SOD-323
- Lead Finish:Matte Tin
- Case Material: "Green" Molding Compound.
- UL Flammability Classification Rating 94V-0
- Moisture Sensitivity: Level 3 per J-STD-020
- Tape Reel :3000pcs

## Applications

- LED Lighting Modules
- RS232/RS485
- CAN and LIN Bus
- Portable Instrumentation
- General Purpose I/O
- Automotive application

## Marking Information

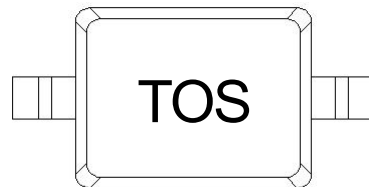

TOS =Marking Code

#### Absolute Maximum Ratings (T=25°C, RH=45%-75%, unless otherwise noted)

Parameters	Symbol	Value	Unit
Peak Pulse Power (tp=8/20μs waveform)	P <sub>PP</sub>	2062	W
Peak Pulse Current (8/20μs)	I <sub>PP</sub>	125	A
ESD per IEC 61000-4-2 (Air) ESD per IEC 61000-4-2 (Contact)	V <sub>ESD</sub>	±30 ±30	KV
Operating Temperature Range	T <sub>J</sub>	-55 to +125	°C
Storage Temperature Range	T <sub>stg</sub>	-55 to +150	°C

#### Electrical Characteristics (T=25°C, RH=45%-75%, unless otherwise noted)

Parameter	Symbol	Test Condition	Min	Typ	Max	Unit
Reverse Working Voltage	V <sub>RWM</sub>				4.5	V
Reverse Breakdown Voltage	V <sub>BR</sub>	I <sub>R</sub> = 1mA	4.7		7	V
Reverse Leakage Current	I <sub>R</sub>	V <sub>R</sub> = 4.5V			1	uA
Clamping voltage	V <sub>C</sub>	I <sub>PP</sub> = 50A, T <sub>p</sub> =8/20us		10.1		V
Clamping voltage	V <sub>C</sub>	I <sub>PP</sub> = 125A, T <sub>p</sub> =8/20us			16.5	V
Junction capacitance	C <sub>J</sub>	V <sub>R</sub> = 0V, f = 1MHz			450	pF

Typical Characteristics

FIG1: Power rating derating curve

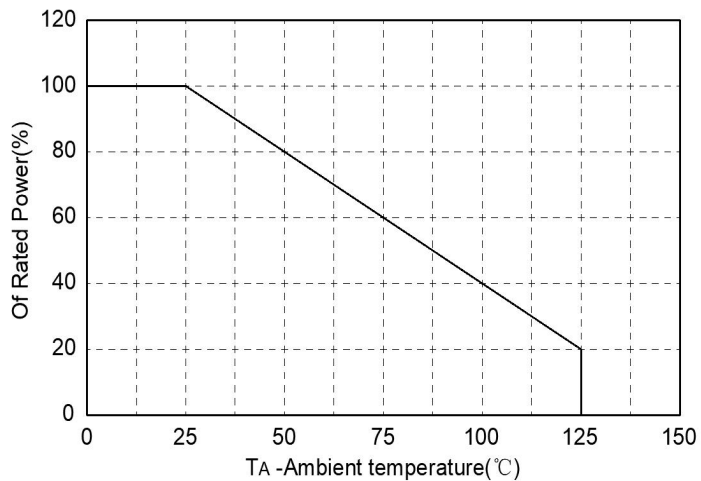

FIG2: pulse Waveform

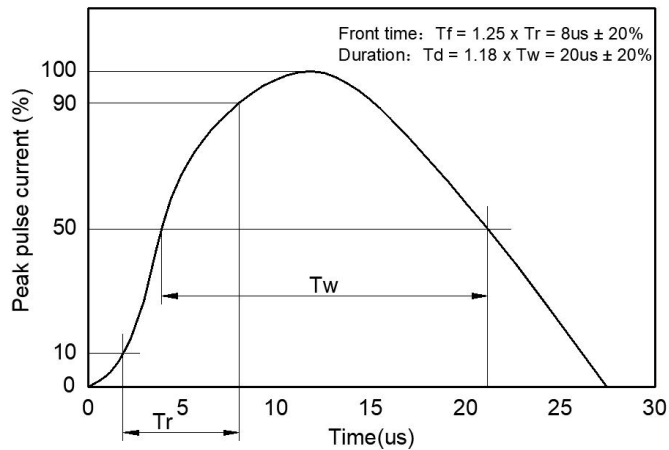

FIG3: Capacitance between terminals characteristics

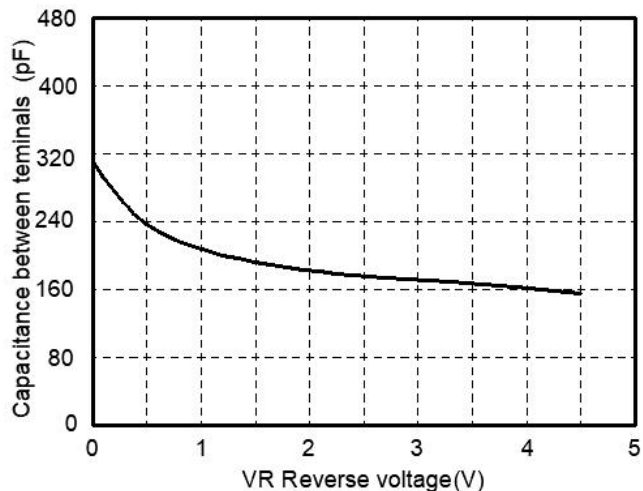
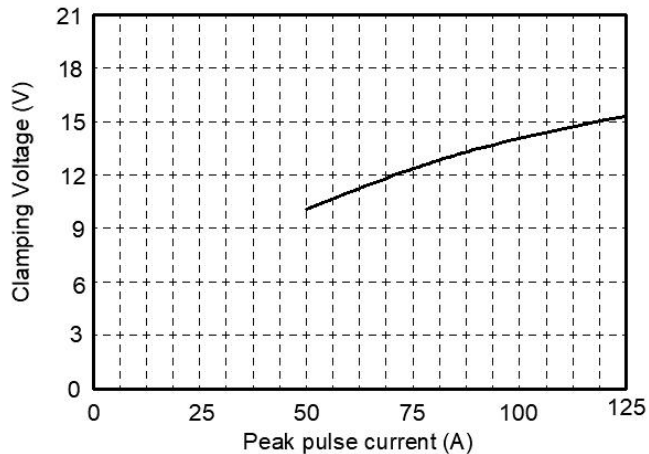
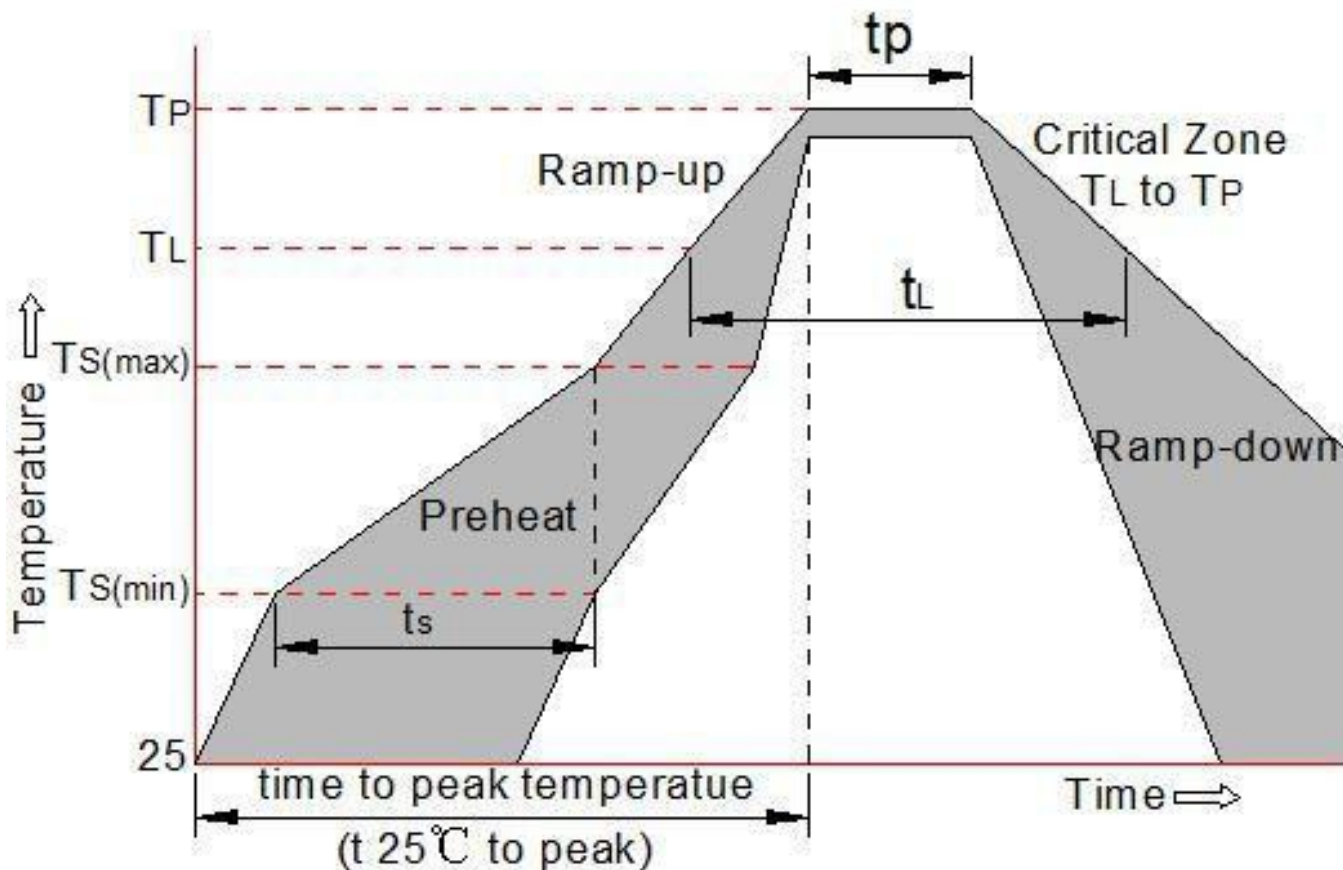

FIG4: Clamping Voltage vs. Peak Pulse Current



### Soldering parameters

Reflow Condition		Pb-Free assembly (see as below)
Pre Heat	-Temperature Min ( $T_{s(min)}$ )	+150°C
	-Temperature Max( $T_{s(max)}$ )	+200°C
	-Time (Min to Max) ( $t_s$ )	60-180 secs.
Average ramp up rate (Liquid us Temp ( $T_L$ ) to peak)		3°C/sec. Max
$T_{s(max)}$ to $T_L$ - Ramp-up Rate		3°C/sec. Max
Reflow	-Temperature( $T_L$ ) (Liquid us)	+217°C
	-Temperature( $t_L$ )	60-150 secs.
Peak Temp ( $T_p$ )		+260(+0/-5)°C
Time within 5°C of actual Peak Temp ( $t_p$ )		30 secs. Max
Ramp-down Rate		6°C/sec. Max
Time 25°C to Peak Temp ( $T_p$ )		8 min. Max
Do not exceed		+260°C



Package mechanical data

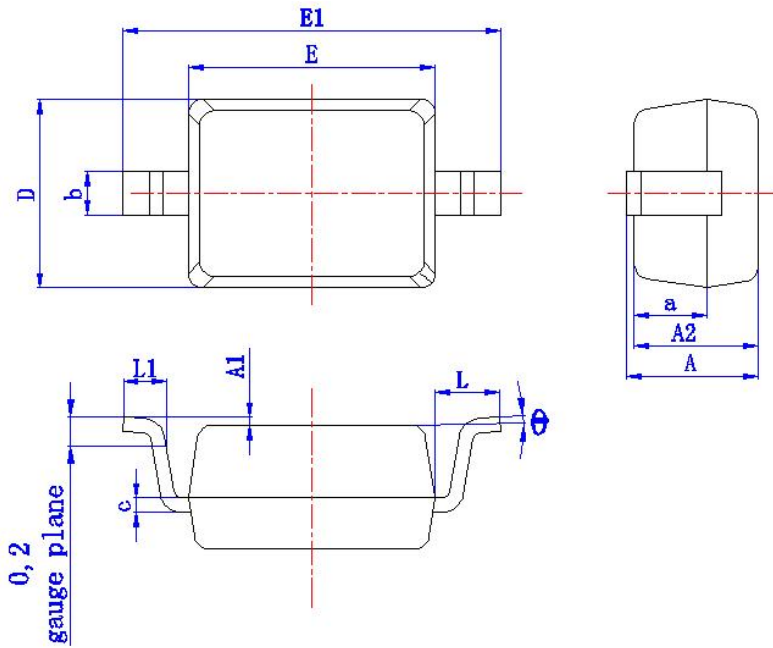

Symbol	Millimeters	
	Min.	Max.
A	0.80	1.15
A1	0	0.1
A2	0.8	1.0
a	(0.5)	
D	1.15	1.45
E	1.60	1.85
E1	2.5	2.8
b	0.25	0.40
c	0.08	0.15
L	(0.475)	
L1	0.25	0.45
θ	0°	8°

Suggested Land Pattern

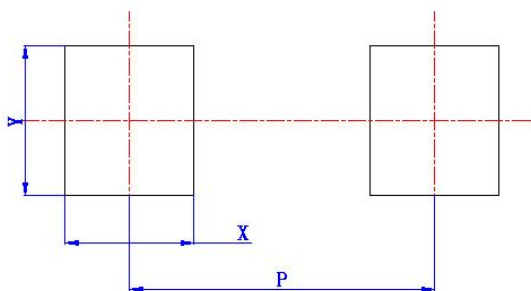

Symbol	Dimension in Millimeters
	Typ.
X	(0.7)
Y	(0.7)
P	(2.3)